

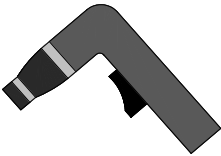

ARCONE® EAGLE®

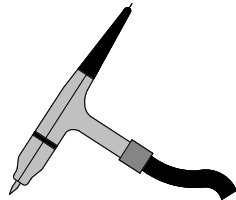
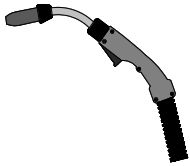
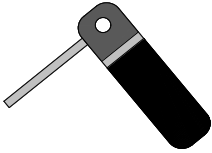
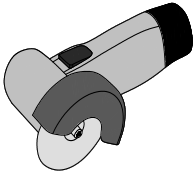

EN 379: A3				

ARCONE® is a Division of A.C.E. International Company
 85 Independence Drive, Taunton, MA 02780, USA
 TEL: +1 (508) 884-9600 • TOLL FREE: +1 (800) 223-4685

OR

Please visit our website: www.arc1weldsafe.com
eu.arc1weldsafe.com





Warnings

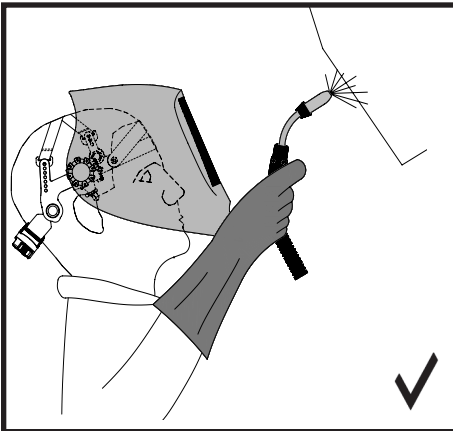
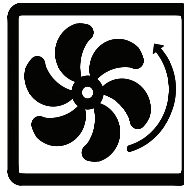
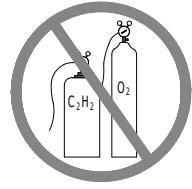
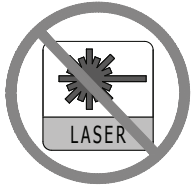
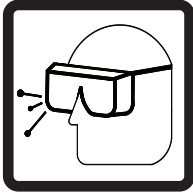
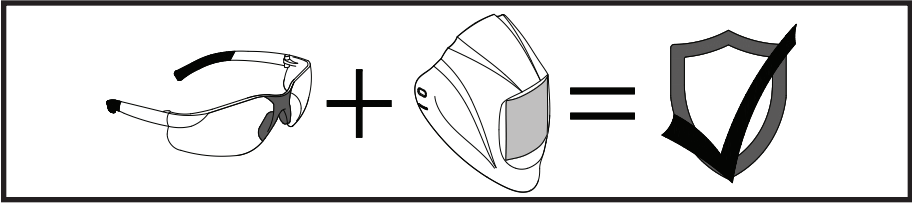

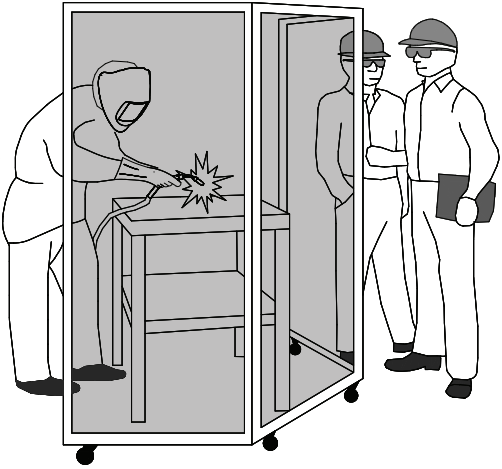
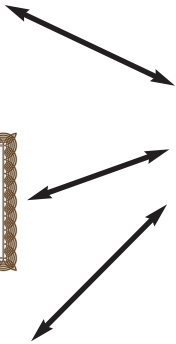

NFPA 51B
ANSI Z49.1
ISO 11611:2015

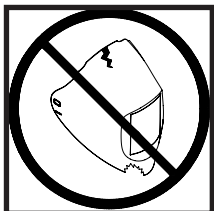
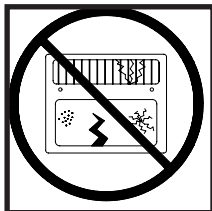
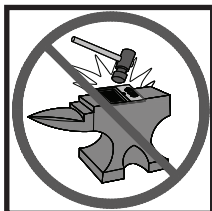
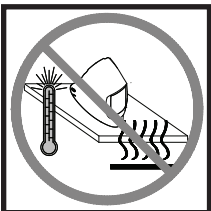
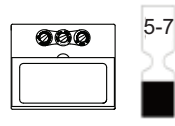
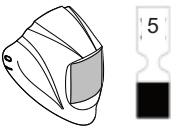
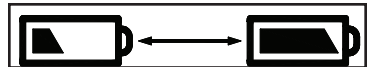
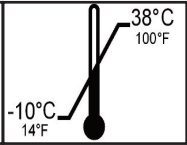
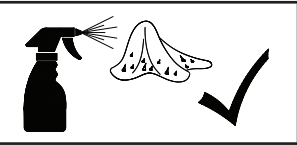
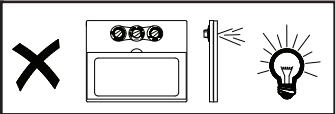
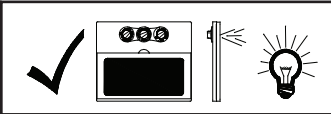
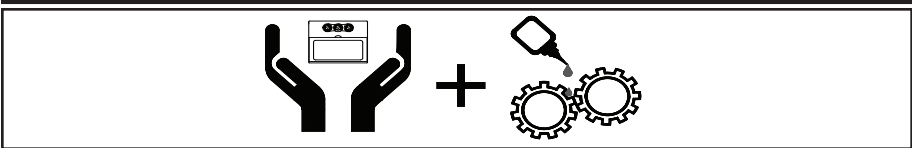

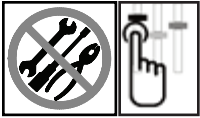

5500V

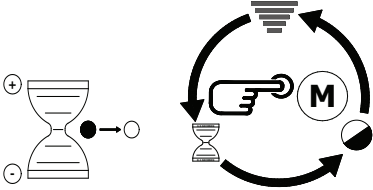
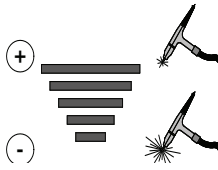
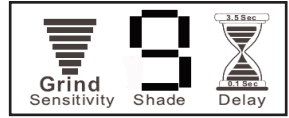

9-13

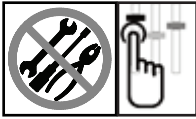

7500VX

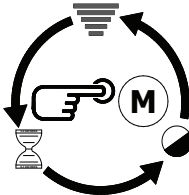
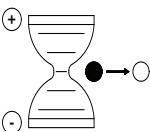
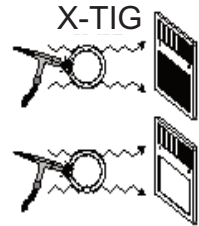
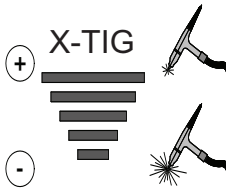

5-14

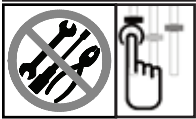

iDF48 Auto

5-9

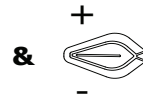
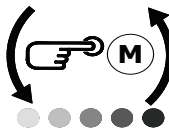

8-13

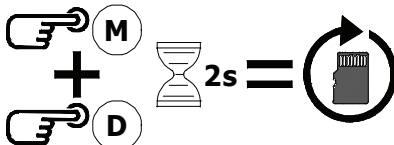

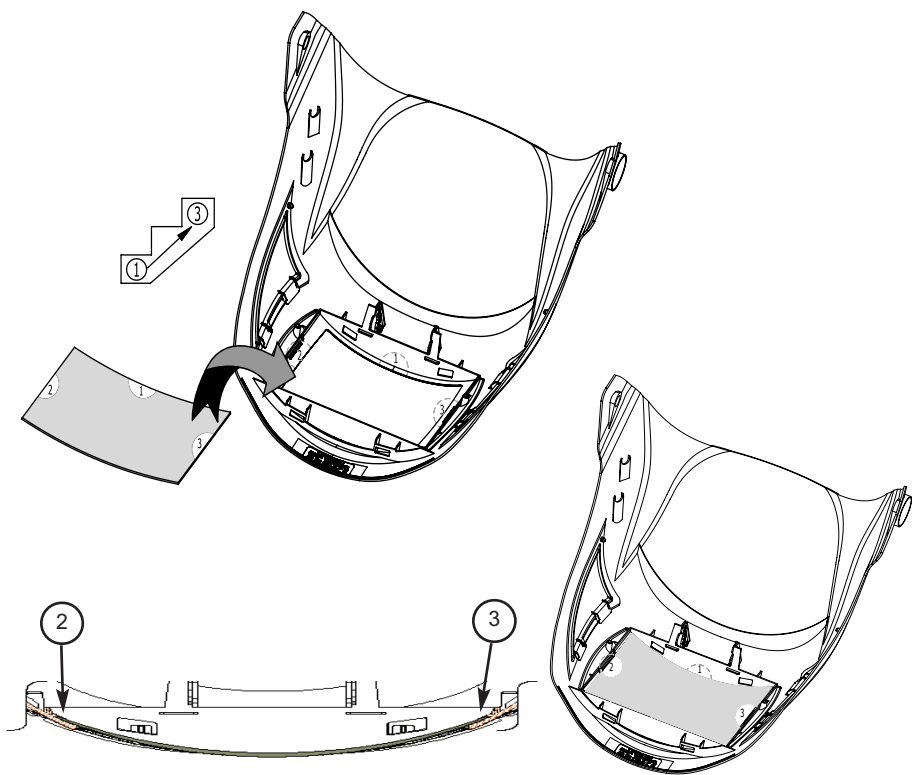
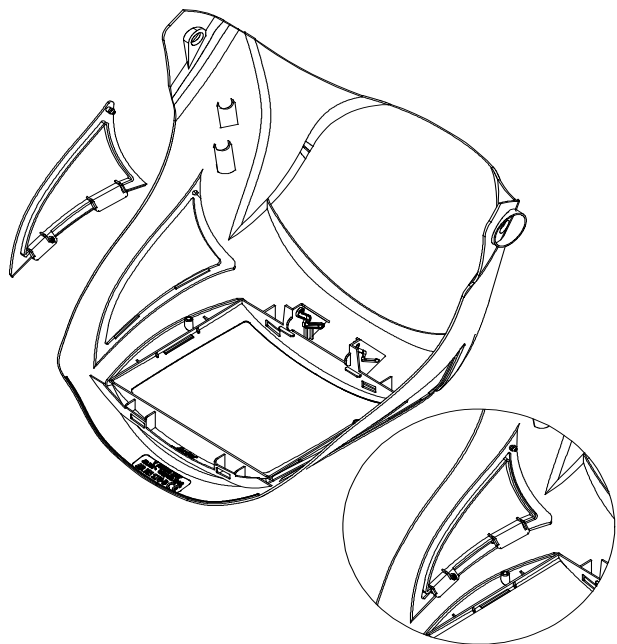

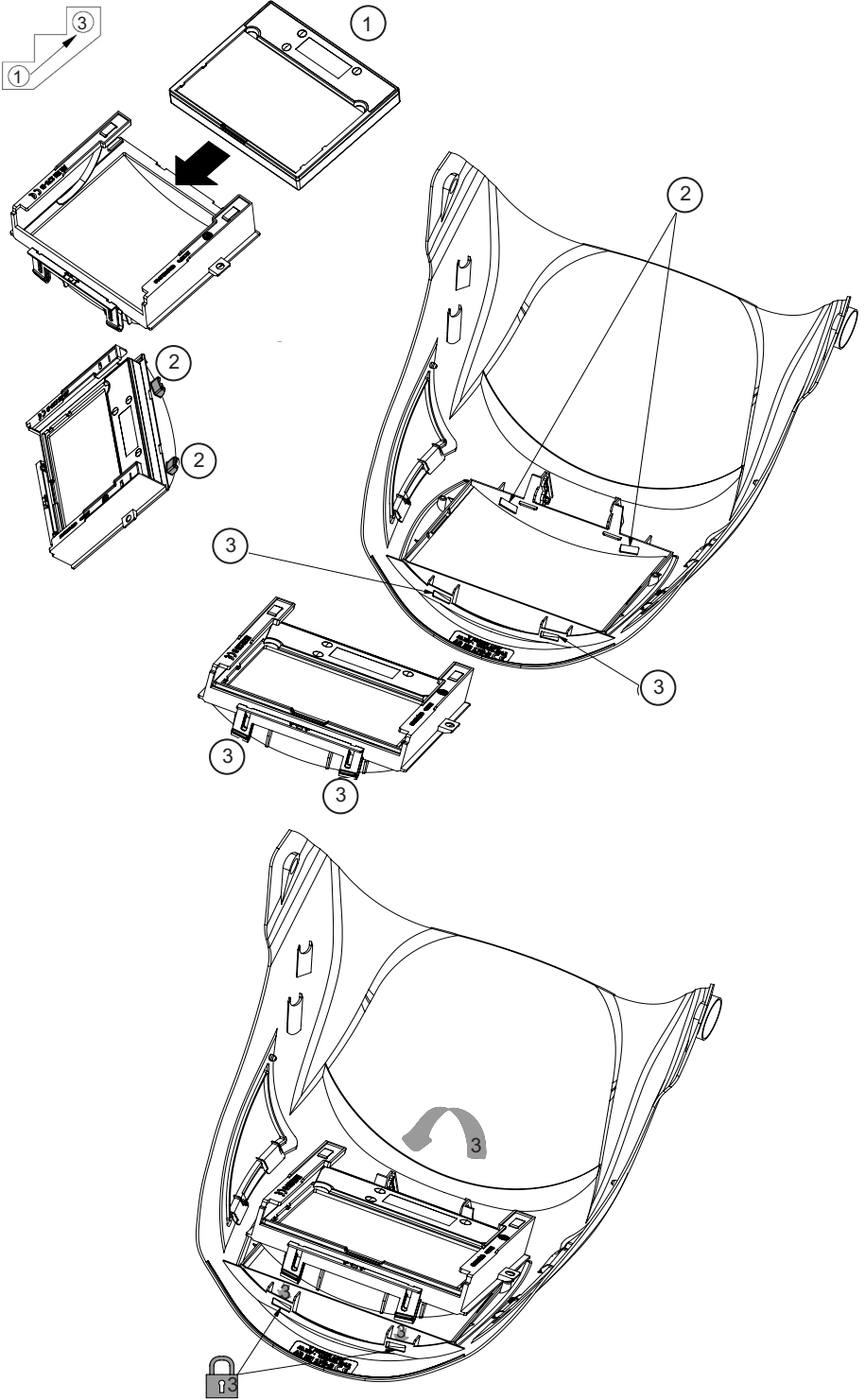

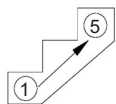

Eagle® Visor

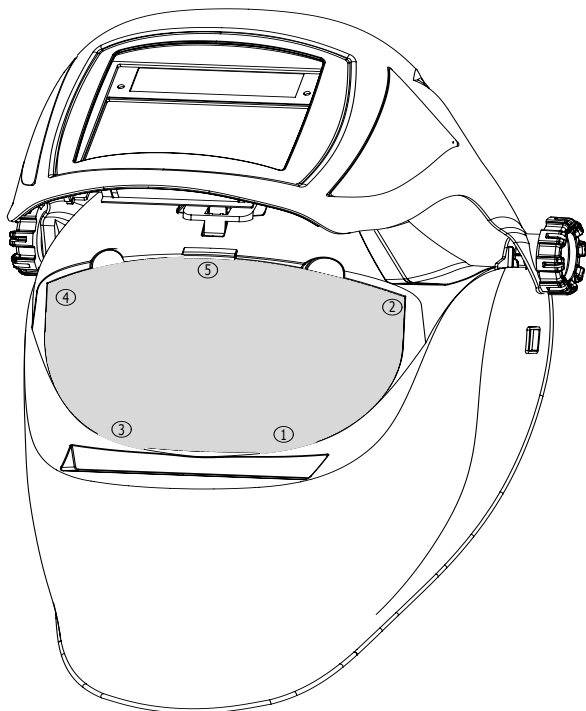
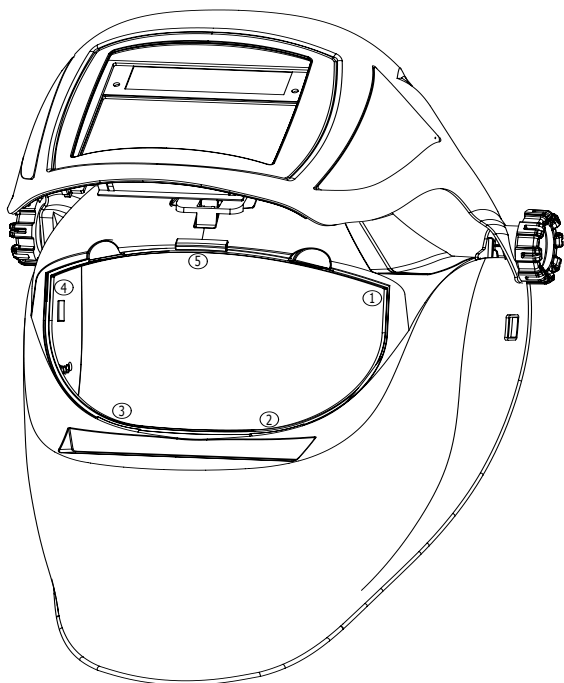
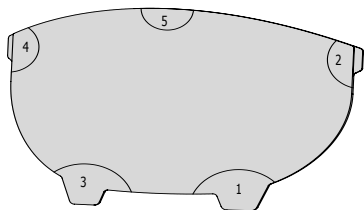

Significance of Markings:



- Z87 = ANSI Standard for Eye and Face Protectors
- W = Welding Filter
- CAN/CSA Z94.3 = CSA Standard for Eye and Face Protectors
- CE = European Mark
- M = Auto-Variable (not shown, iDF48 only)
- 4 = Light Shade Number
- 9-13 = Dark Shade Range
- AR = ArcOne's Manufacturer's Mark
- 1 = Optical Class
- 1= Diffusion of Light Class
- 1= Variation in Luminous Transmittance Class
- 2= Angle Dependency Class
- EN 379 = CE Welding Filter Standard

AR EN 166 1 B

AR Z87+ U6

- CE = European Mark
- EN 166 = CE Eye Protection Standard
- 1 = Optical Class
- B = Impact Class (Medium Energy)
- AR = Manufacturer's Mark
- Z87+ = ANSI Standard for Eye and Face Protectors Impact Rated
- U6 = ANSI Ultraviolet Filter Scale Number

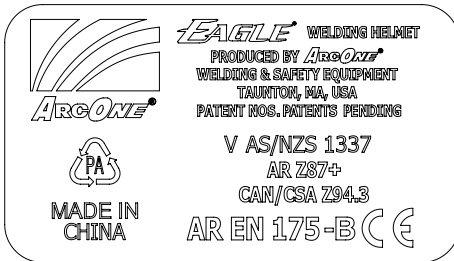

- EN 175 = CE Welding Helmet Standard
- B - Impact Class (Medium Energy)*

Product Certification Bodies

IDF48, 5500V:
 ECS GmbH (1883)
 Obere BahnstraBe 25
 73431 Aelen - Germany

7500VX, Eagle Helmet, Eagle Visor:
 DIN CERTCO (0196)
 Alboinstrasse 56
 12103 Berlin, Germany

INSPEC International (0194)
 56 Leslie Hough Way
 Salford
 Greater Manchester
 M6 6AJ, England



*** NOTE:** If protection against high speed particles is required at extreme temperatures, only use a protector where the Impact Class is followed by a "T", e.g. -BT. Otherwise, use at room temperature.

