

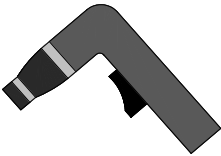

ARCONE® EAGLE®

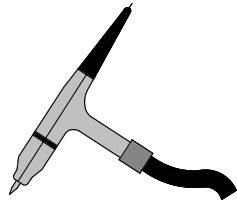
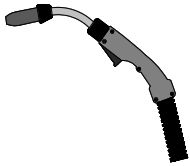
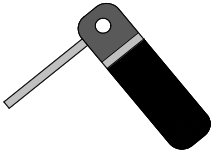
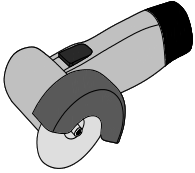

EN 379: A3				

ArcONE® is a Division of A.C.E. International Company
 85 Independence Drive, Taunton, MA 02780, USA
 TEL: +1 (508) 884-9600 • TOLL FREE: +1 (800) 223-4685

or

Please visit our website: www.arc1weldsafe.com
eu.arc1weldsafe.com





Warnings

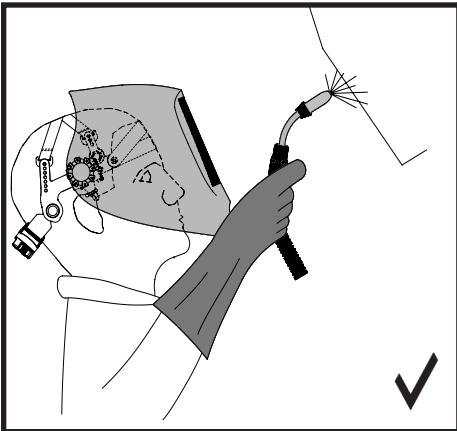
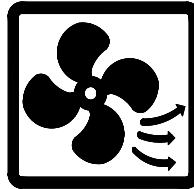
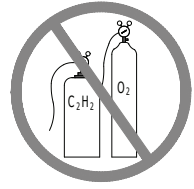
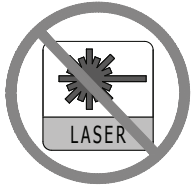
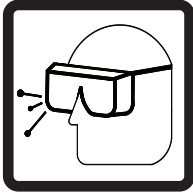
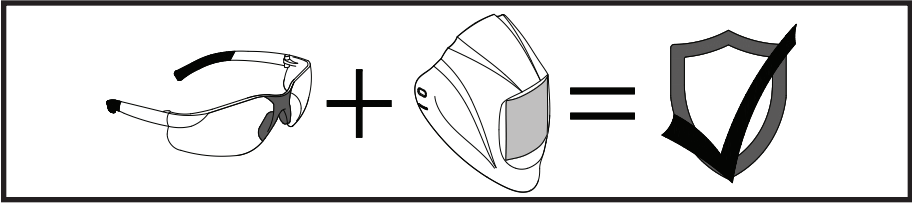

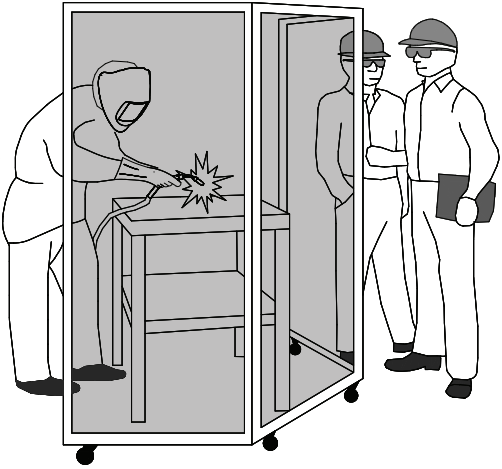
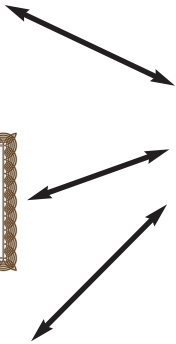

NFPA 51B
ANSI Z49.1
ISO 11611:2015

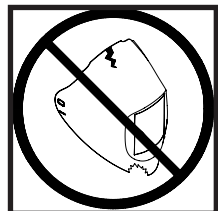
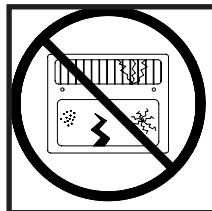
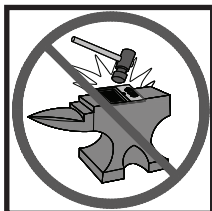
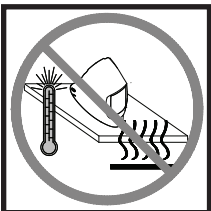
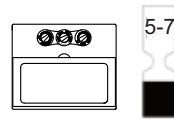
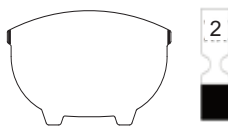
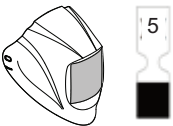
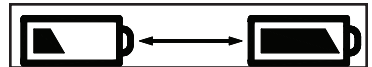
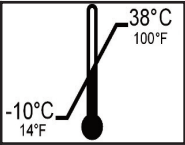
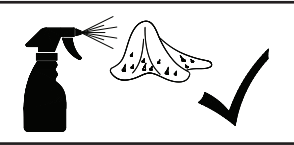
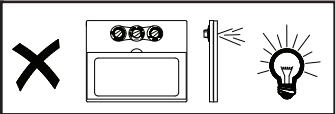
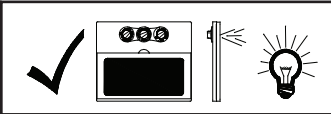
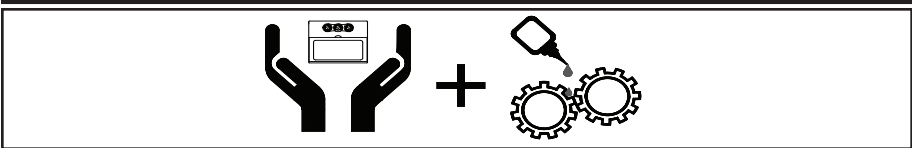

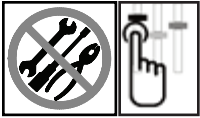

5500V

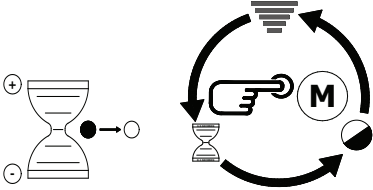
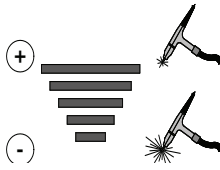
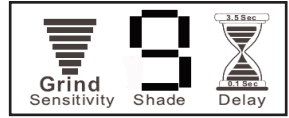

9-13

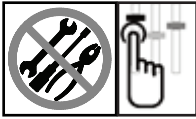

7500VX

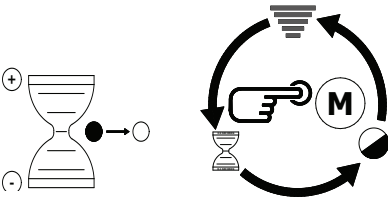
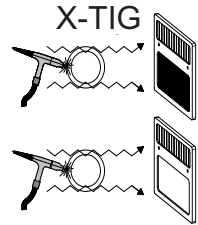
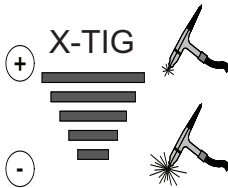

5-14

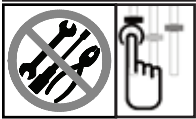

iDF48 Auto

5-9

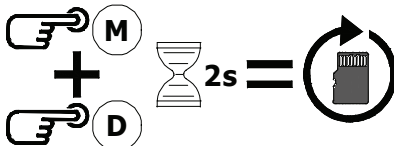
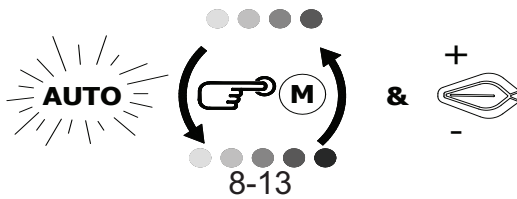

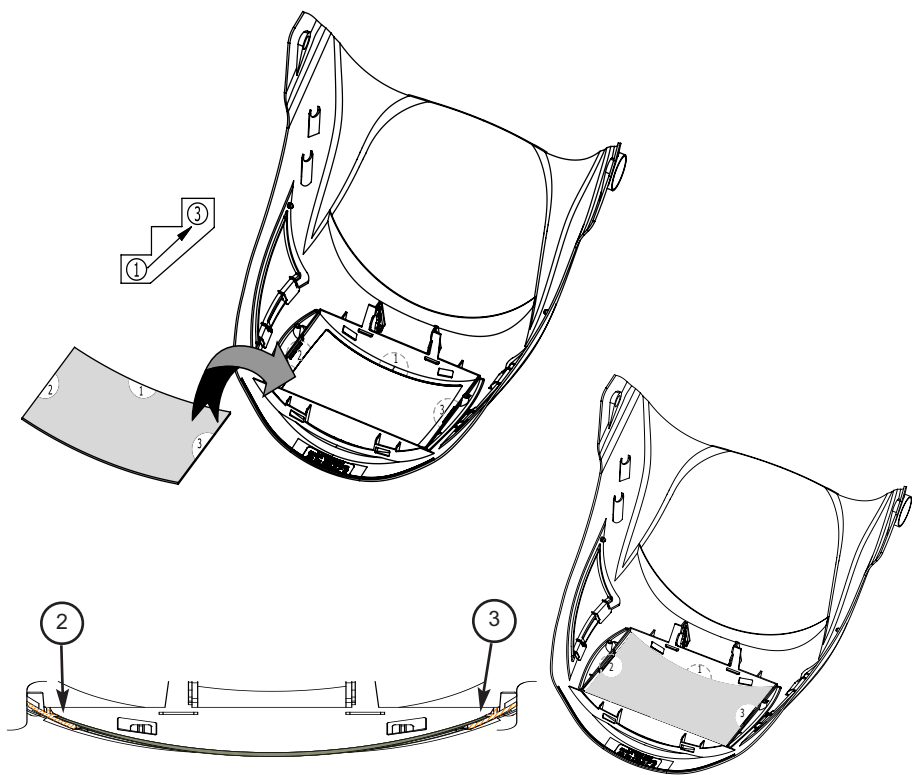
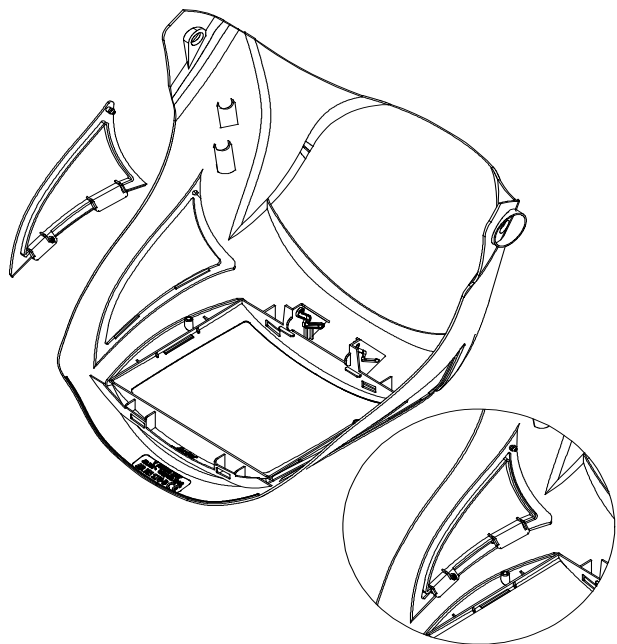

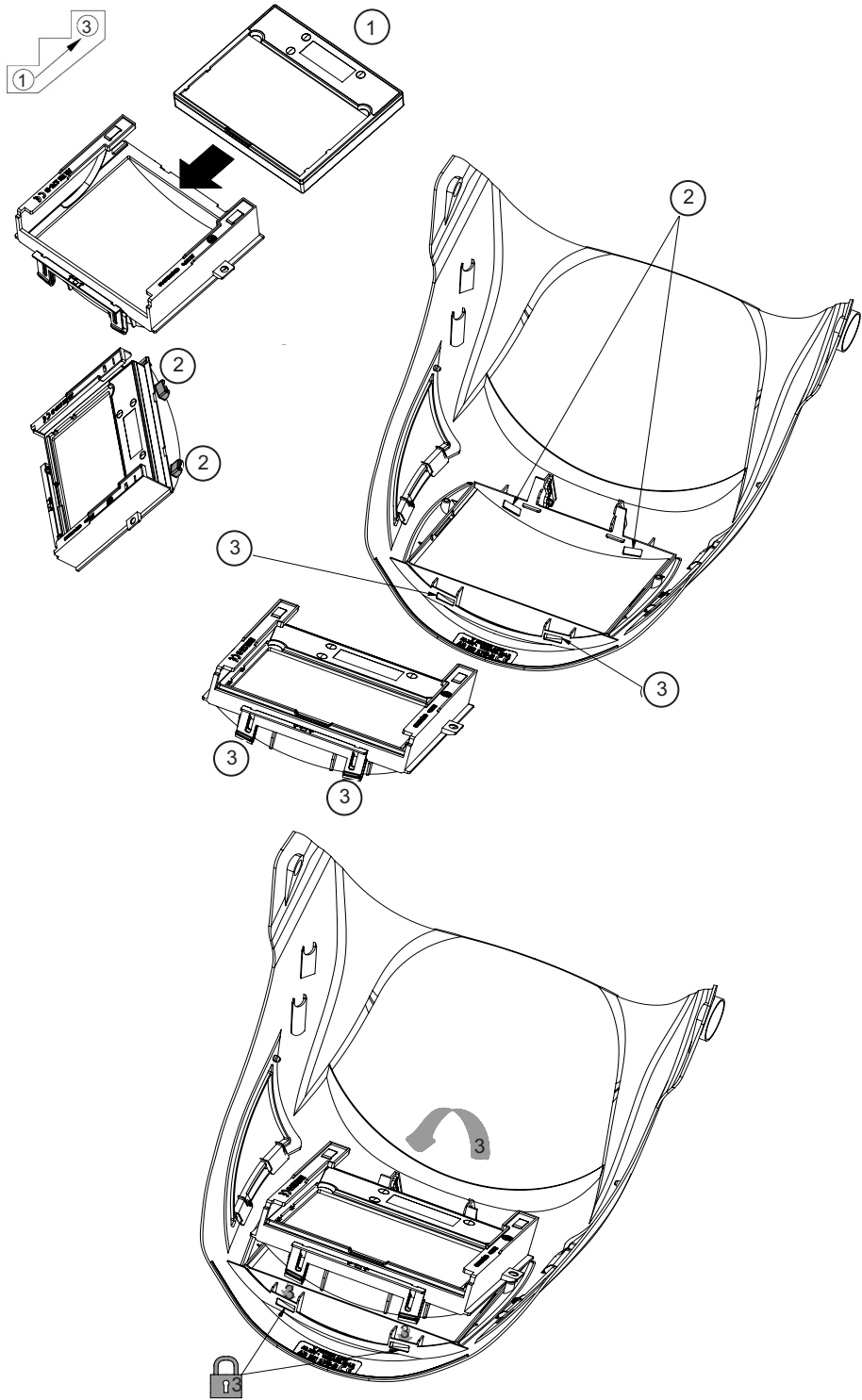

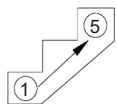

Eagle® Visor

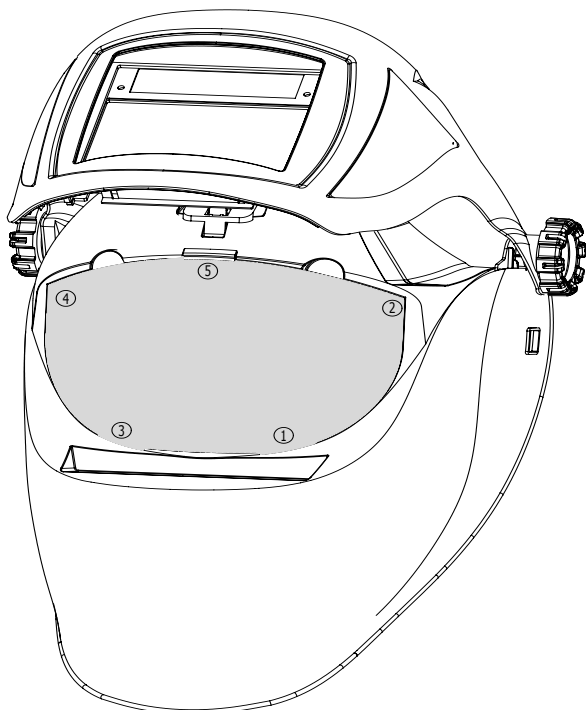
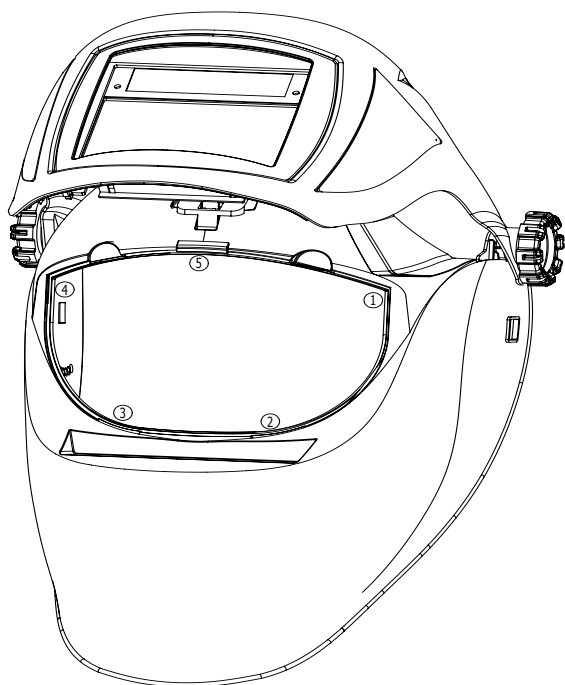
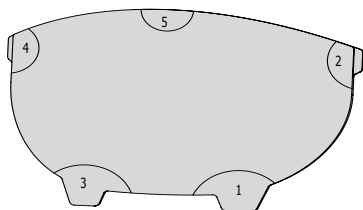

Significance of Markings:



Z87 = ANSI Standard for Eye and Face Protectors

W = Welding Filter

CAN/CSA Z94.3 = CSA Standard for Eye and Face Protectors

0196 = Product Certification Body Number (see below)

CE = European Mark

M = Auto-Variable (iDF48 only)

4 = Light Shade Number

9-13 = Dark Shade Range

AR = ArcOne's Manufacturer's Mark

1 = Optical Class

2 = Diffusion of Light Class

1 = Variation in Luminous Transmittance Class

3 = Angle Dependency Class

EN 379 = CE Welding Filter Standard

AR EN 166 1 B

AR Z87+ U6

CE = European Mark

EN 166 = CE Eye Protection Standard

1 = Optical Class

B = Impact Class (Medium Energy)

AR = Manufacturer's Mark

Z87+ = ANSI Standard for Eye and Face Protectors Impact Rated

U6 = ANSI Ultraviolet Filter Scale Number

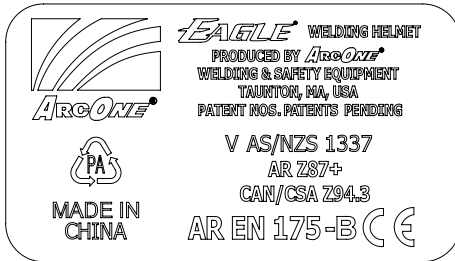

EN 175 = CE Welding Helmet Standard

-B - Impact Class (Medium Energy)*

Product Certification Bodies

IDF48, 5500V:

ECS GmbH (1883)
Obere Bahnstraße 25
73431 Aelen - Germany

7500VX, Eagle Helmet, Eagle Visor:

DIN CERTCO (0196)
Alboinstrasse 56
12103 Berlin, Germany

INSPEC International (0194)

56 Leslie Hough Way
Salford
Greater Manchester
M6 6AJ, England



* **NOTE:** If protection against high speed particles is required at extreme temperatures, only use a protector where the Impact Class is followed by a "T", e.g. -BT. Otherwise, use at room temperature.

